

TDS21 WIFI FAN COIL THERMOSTAT



I. Product Summary:

TDS21 WIFI Fan Coil Thermostat is touch screen thermostat with WIFI Function, the thermostats can be controlled by phone App.(IOS and Android phone)

It is designed to control the fans and valves in air conditioner applications via comparison of the room temperature after setting a temperature as reaching the aim of comfort and saving energy.

II. Technical Parameter:

Power Supply	AC200~240V 50~60Hz
Current Load	3A~5A
Power Consumption	<0.5W
External Material	PC+ABS (flame retardant)
Sensing Element	NTC
Set Temp. Range	10-40°C
Accuracy	±1°C
Dimension	86x86x13.3mm
Ambient Temp.	0-45°C, 5-95%RH(Non-condensing)
Storage Temp.	-5~55°C
Timing Error	<1%

III. Main Functions and Characteristics

1. Heating, cooling, ventilation mode.
2. WIFI for Android & Apple IOS phone.
3. Large Glass screen display and touch screen type.
4. 2 pipe and 4 pipe for choose.
5. 3 fan speed+Auto.
6. Programmable timing switch function, 4 period a day setting.
7. Temperature compensation when differs from actual temp.
8. Selectable 80mmx80mm European hidden box.
9. Key Lock function.
10. Fan coil in-control and out-of-control adjustable. (only for 2 pipe)

IV. User Interface Explanation (Thermostat Port)

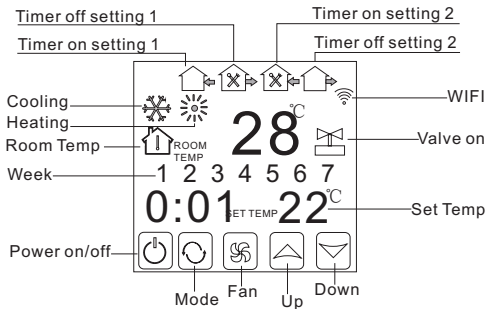

V. User Interface Explanation (Phone Port)



VI. Model Spec

Model	Current Loading	Program Time switch	Key Lock	Controlled Objects
TDS21WIFI-AC2	3A~5A	✓	✓	2 pipe central air conditioner
TDS21WIFI-AC4	3A~5A	✓	✓	4 pipe Central air conditioner

VII. Dimension

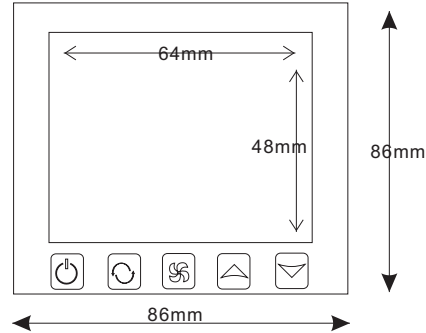

VIII. Wiring Diagram

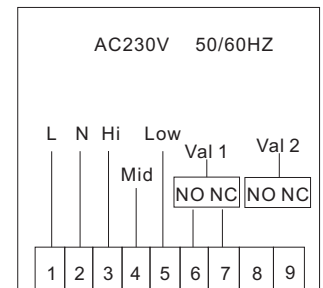
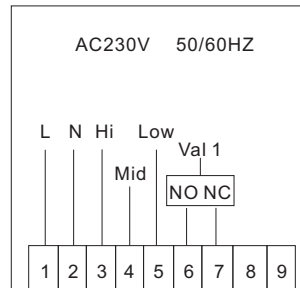

IX. Thermostat Operation Instruction

1. Setting Power on/off

Press to turn on/off the power.

2. Setting Temperature

Press to set the temperature.

3. Setting the System Mode

Press to select heating, cooling or ventilation. Factory Default is ventilation.

4. Setting the Fan Speed

Press to select the fan speed.

is Low speed (Factory default);

is Mid speed;

is High speed;

is Auto speed.

In auto mode, the fan will run according to the comparison of room temperature and set temperature.

5. Setting the Real Time.

Press and hold for 3 sec., hh will flash in the position of hh: mm.

Press to adjust the current hour.

Press , mm will flash in the position of hh: mm.

Press to adjust the current minute.

Press , 1 will flash in the position of week: 1234567.

Press to adjust the current week.

6. Setting the Time-on(Regular Boot)

Press for more than 3 seconds, after setting the time, continue to press until and "hh" twinkling. Press to adjust the hours.

After the adjustment of hours, press until the "mm" twinkling, press to adjust the minutes.

After the completion of all adjustments, press to confirm, then does not twinkle, Regular boot setup is complete.

The operation of canceling Regular boot is the same, press to the state of Regular boot, then pressing , the is twinkling, Regular boot has been canceled.

7. Setting the Timer off

After the setting of Regular boot, press again, until and "hh" twinkling, press to adjust the hours.

After the adjustment of hours is completed, press until the "mm" twinkling, press to adjust the minutes.

After the completion of all adjustment, press to confirm, then does not twinkling, Off timer setup is completed.

The operation of canceling Off timer is the same, press to the state of Off timer, then pressing , the is twinkling, Off timer has been canceled.

The setting of the third period and fourth period are same with the first and second period, the icons are (on, off/into the house, out of the house)

8. Setting the Circulation of Timer Switch

After setting the time of timer switch, continue to press the , there will be "Loop", then press , week display area will displays the day of the week, or the transformation of "12345" "123456", or "1234567".

If the screen only displays the day of the week, then the timer switch setting is valid only for the day.(= "Execute once" in App interface)

If it displays "12345", then the timer switch is valid from Monday ~ Friday, and Saturday and Sunday will be invalid.

If it displays "123456", then the timer switch is valid from Monday ~Saturday, and Sunday will be invalid.

If it displays "1234567", then the timer switch is valid from Monday ~ Sunday.

9. Advanced Setting Mode

In power-off state, press and meanwhile, to enter into Advanced Setting.

Press to switch dIF, Sh1, SI2, Sh2, SI2, ADJ, FAN, FrE, LOC, ADD, FAC.

Display code	Function	Parameters	Factory default
dIF	Deadzone/hysteresis	0.5°C; 1°C	1°C
SH1	Max temp in cooling	10~40°C	40°C
SL1	Min temp in cooling	10~40°C	10°C
SH2	Max temp in heating	10~40°C	40°C
SL2	Min temp in heating	10~40°C	10°C
Adj	Temp. Calibration	-5~5°C	0°C
FAN	Fan coil control mode	0:fan coil in-control 1:fan coil out off control	0
FrE	Anti-freeze function	0:Anti-freeze On 1:Anti-freeze Off	0
LOC	Key lock(button lock)	0:Unlock 1:All locked except 2:All button locked	0
Pon	Working state memory function	when power fails suddenly, working state memory or not 00: no memory 01: memory	00
FAC	Factory setting	00: Factory reset 08:Just display	08

Advanced Setting in "BEOK AC" App interface is "Senior"

Touch press for 2 second, you will enter into Advanced Setting interface.

X. Phone Port Operation Instruction

1. Install APP on phone

For IOS system: Login in App Store, search "Beok AC", you can download it on your iphone. Or scan below code to download:



For Android System: Login in Google Play, search "Beok AC", you can download it on your phone. Or scan below code to download:



2. Connection Thermostat with Phone

Thermostat part Setting

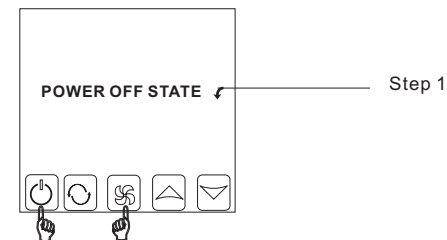

Press and hold , then press button the same time for 2 seconds, then will enter into Advanced Setting.

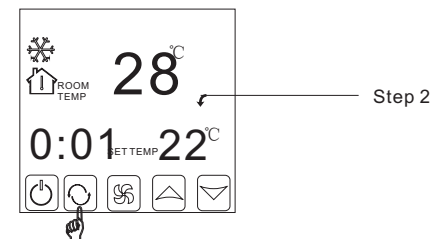

After enter into Advanced Setting, press 10 times until "FAC" appears.

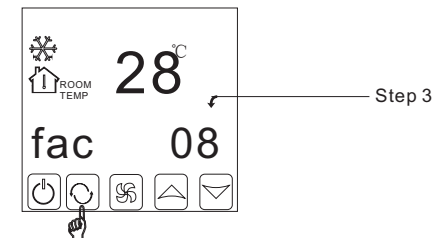

When FAC appears, press to change 08 to 10 or 32, make FAC=10 or FAC=32.

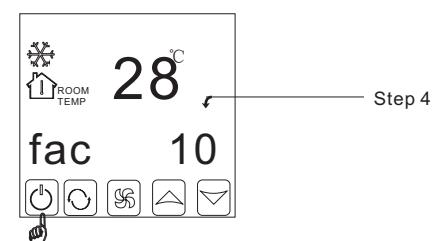

Then, press to power-off state.

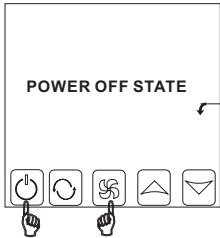

Step 5

Hold on **Wi-Fi** button, then press **Power** again for 2 seconds, then you can find the WIFI symbol twinkling.

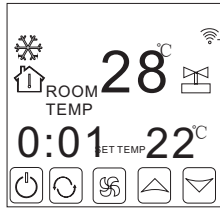

When the wifi symbol twinkling quickly and frequently: Connection can start

When wifi symbol twinkling slowly: It means Off Line

When twinkling Stops: Connection successfully.

At this time, wifi symbol will be twinkling quickly and frequently. It means, you can connect thermostat with phone now.

When wifi symbol stop twinkling, it means thermostat is successfully connected with your phone.

Phone part setting

During the WIFI symbol twinkling, Open "Beok AC" APP on your phone, you can see APP welcome page.



1. When the thermostat Wifi Symbol twinkling fast and continually, you can start the configure on your Phone App.

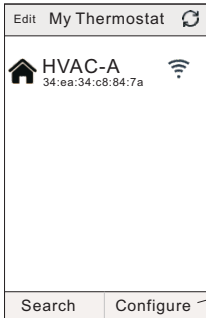

Press Configure key

2. Enter your wifi name and password, then press start connection at below. When connection successfully, it will appear "Connection Success".



Attention: Only when the WIFI symbol twinkling continually, thermostat connection with phone will be successfully. If wifi twinkling stops but connection didn't finish, enter into Advanced setting to adjust wifi symbol again.

3. After connection success, you need press "Search" key.



Press Search key

4. Then it will appear your wifi thermostat HVAC. HVAC is the factory setting name, when you have more than 2 thermostats, you can change it to any name you want.

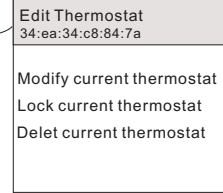
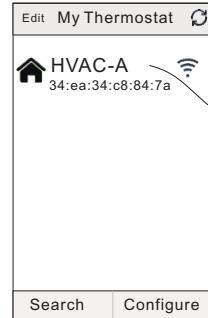

- Long press HVAC for 5 seconds, it will appear Edit Thermostat page. (IOS phone: slide to left, to edit.)
- Press Modify Current Thermostat.
- For examples: You can change HVAC to room 1, Bedroom Bath room, or anything you like.

APP Interface on the Phone

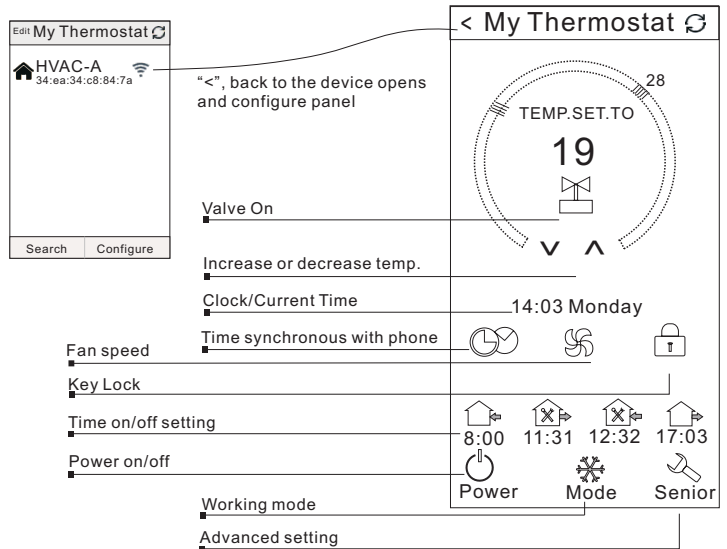

"<", back to the device opens and configure panel

Thermostat Setting through Phone Operation

- Clock**
Press to make the thermostat time synchronize with the current time (your phone time). You will see the words "Time sync success"
- Fan Speed Setting**
Press to select the fan speed (Low speed, Medium speed, High speed, Auto)
- Key Lock**
Press in the App interface, to lock the button of thermostat. (Go into Advanced setting, you will find 3 locking way. Unlock; Lock all button except power button; Lock all button)

4. Time Switch

Press 2 seconds to enter into time switch working, you will find bellows:

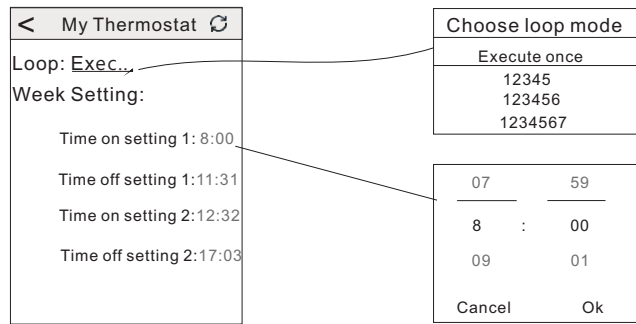

Choose loop mode

Execute once: It means temporary Time on/off for a short time. (several hours or a day)
 12345: It means time on/off setting, from Monday-Friday the same.
 123456: It means time on/off setting, from Monday-Saturday the same.
 123457: It means time on/off setting, from Monday-Sunday the same.

Week setting

You can set 4 time on/off period. For example,

For example:

8:00am time-on, 11:31am time-off. (first time switch circle)

Thermostat start working automatically from 8:00am-----11:31am

5. Working mode

Press on the app, you will find 3 working mode for choose.

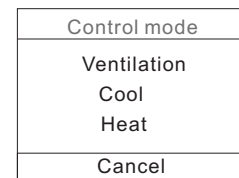

5. Senior (Advanced setting)

Press for 2 seconds, you will enter into Advanced setting.

① dIF
 dif=deadzone/ hysteresis for room temp.
 Eg, Set=22°C, dif=1°C, in cooling mode.
 When temp drop to 21°C, the relay stop outputing.
 When temp up to 22°C, relay output again and cooling

② SH 1
 ③ SL 1
 ④ SH 2
 ⑤ SL 2
 ⑥ AdJ

When thermostat temp differs from the real temp, you can do some calibration.
 Calibration range -5~5°C

⑦ FAN
 Fan Coil Controlling Mode Setting
 (You can select the fan coil In control & Out-of-control.)

In "F00" mode, when room temp reaches to the setted temp, the fan coil stops working.
 In "F01" mode, when room temp reaches to the setted temp, the fan coil goes on working.

⑧ FRE
 Anti-freeze function On when outage, or power-off state, it keep the room temp between 5-7°C to protect your room Especially for heating mode when in cold weather..

⑨ LOC
 Lock the button for thermostats. 3 choice:
 01: button unlock.
 02: lock all button except power on/off button.
 03: lock all button.

XI. Attention to Phone WiFi Connection:

After you press Configure, if connection fails, please check the bellowings:

01. The first time connection, please confirm your mobile phone is WLAN mode, and ensure the (mobile data) 3G/4G turned off. Please connect to 2.4G WIFI, not 5G WIFI.
02. Please add your WIFI router name, we recommend it does not include space.
03. Please check WIFI router password. We recommend < 32 characters, no spaces, no blank password, no special symbols except letters and numbers
04. Please check module is successfully reset. (operate as instruction) In power-off state, Find FAC mode, make FAC=10 or 32, then turn off.....
05. Please confirm WIFI password is correctly filled. We recommend your WIFI password displayed, thus to check password easily.

XII. Installation Instruction

The products suits for standard 80*80mm wall box or 60mm Europe round box.

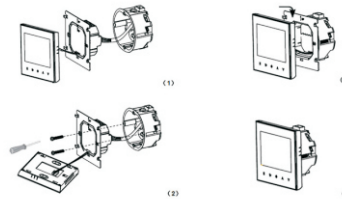

1. Connect the line of power and valve into the terminals. Fix the wall plate into the wall box by a screwdriver.
2. Connect the lines with the LCD board.
3. Connect the LCD board into the wall plate.

XIII. Attention

Thank you for buying this product!

Please read this manual for complete instructions on installing and operating your thermostat. If you require further assistance, please feel free to contact us.

In the box you will find:

Model	TDS21WIFI-AC2	TDS21WIFI-AC4
Thermostat	✓	✓
User Manual	✓	✓
Screws	✓	✓

Our Service:

We offer the warranty of 24 months from the sales day.

During the warranty, if it is belong to the quality issue, we will fix or replace by free after testing.

If it is not quality problem or beyond the warranty time, we will charge for the after-sales service.

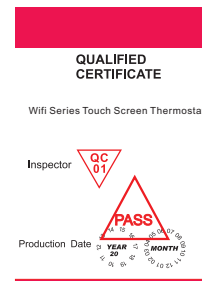

Warning:



The symbol means the unit is being installed, it may cause electrical shock hazard during maintaining, so please make sure it is operated by the professional technical worker.