

Auto-mode Setting (Floor Heating / Integrated)

Press "M" for 3 seconds to edit auto-mode setting.

| Events | Symbols | Time | | Temperature | | |
|----------|---------|---------------|--------|---------------------------|-------------|---------------------------|
| | | Default value | Modify | Default value | Modify | |
| Workdays | 1 | | 06:00 | Press "▲" or "▼" | 20°C (68°F) | Press "▲" or "▼" |
| | 2 | | 08:00 | | 15°C (59°F) | |
| | 3 | | 11:30 | | 15°C (59°F) | |
| | 4 | | 12:30 | | 15°C (59°F) | |
| | 5 | | 17:00 | | 22°C (72°F) | |
| | 6 | | 22:00 | | 15°C (59°F) | |
| Weekends | 1 | | 06:00 | 20°C (68°F) | "▼" | |
| | 2 | | 20:00 | 20°C (68°F) | | |

Timer Task Setting (Fan Coil / Integrated)

Press "⌘" for 3 seconds to enter timer task setting; press "M" to change settings; press "▲" or "▼" to adjust parameters; press "⏻" to save and exit.

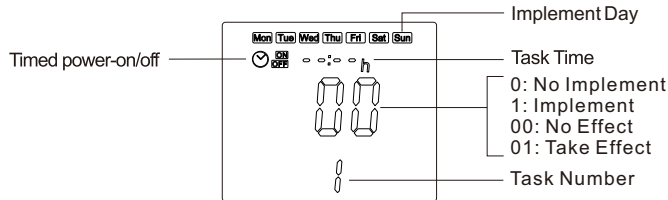

Dimensions (Unit: mm)

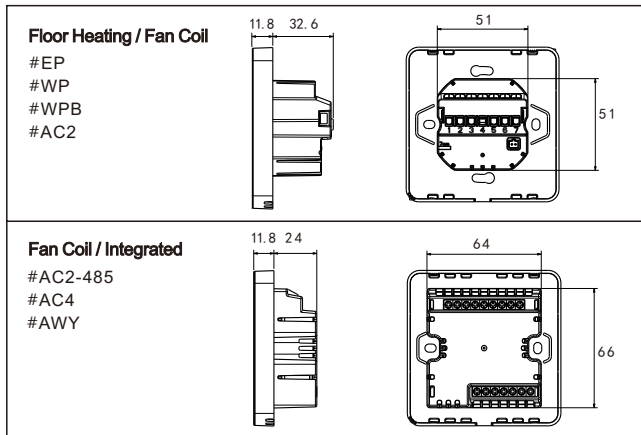

Mounting Steps

The thermostat adopt pre-guide and limited snap-fit design. It is easy to mount.
1) Release front cover by inserting a head screw-driver into bottom crack.

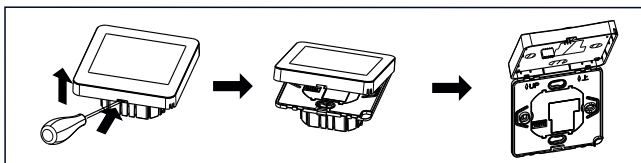

- 2) Insert the wires and then fix these wires with screws. Suggested wire-stripping length is 7-9mm.
- 3) Mount backing plate into wall-cassette, put screws and then fix thermostat. Make sure that the thermostat is fixed without deformation. Suggested torque is 0.2~0.4N.m (2.0~4. 1kgf.cm).

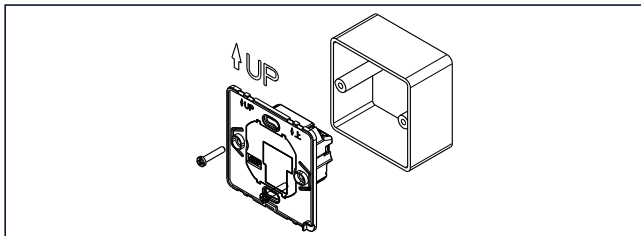

- 4) Re-mount the front cover via snap-fit connection.

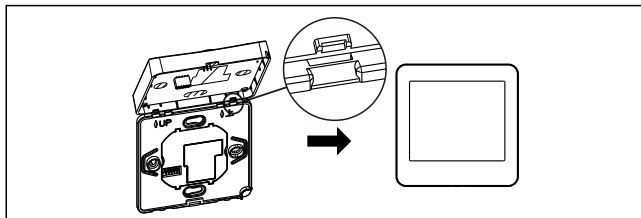

Sensor failure

Please select work mode of sensors correctly. When it shows E0/E1 error, thermostat will stay power-off till the error is eliminated. E0: built-in sensor is short-circuited or disconnected. E1: floor sensor is short-circuited or disconnected.

Connecting Diagram

The thermostat operates in full capacity in areas with the altitude of less than 2500 above sea level. Power rating of external load should be less than or equal to 80% rated power of the thermostat in areas with altitude of 2500m to 4200m.

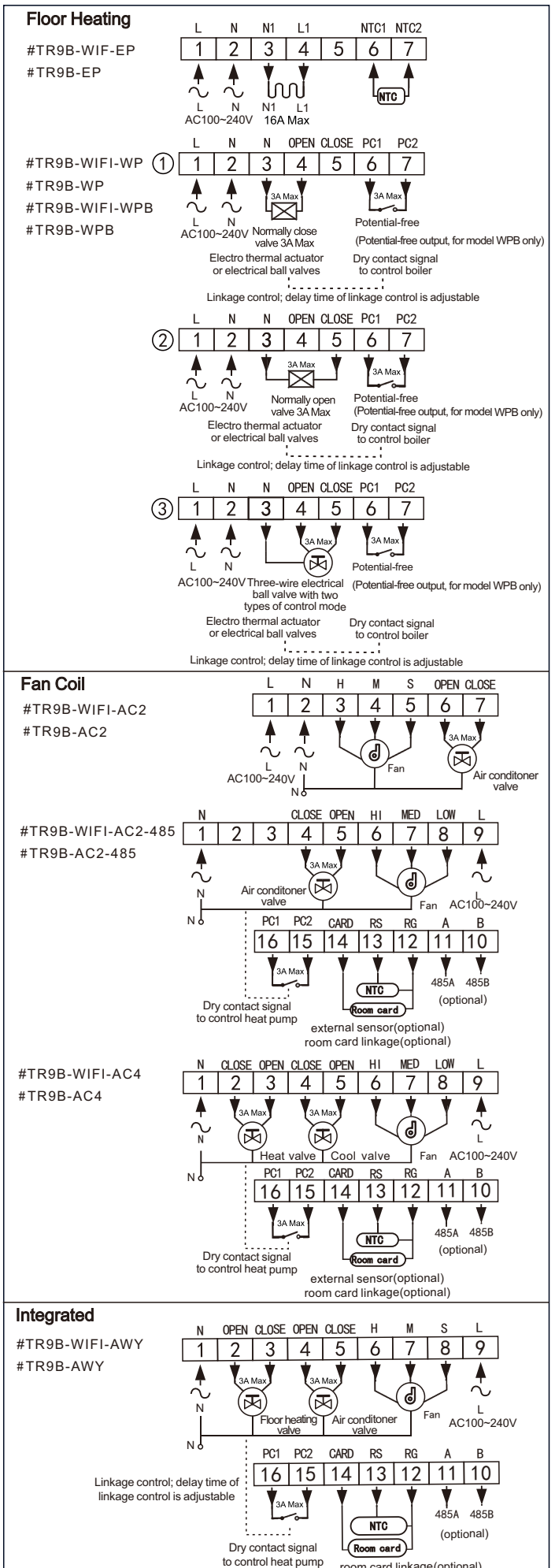

User Guide for Smart Life



Version:1.1(07.2022)
71.04.00062

2 Bluetooth Mode

*Please turn on the Bluetooth of your phone in advance.

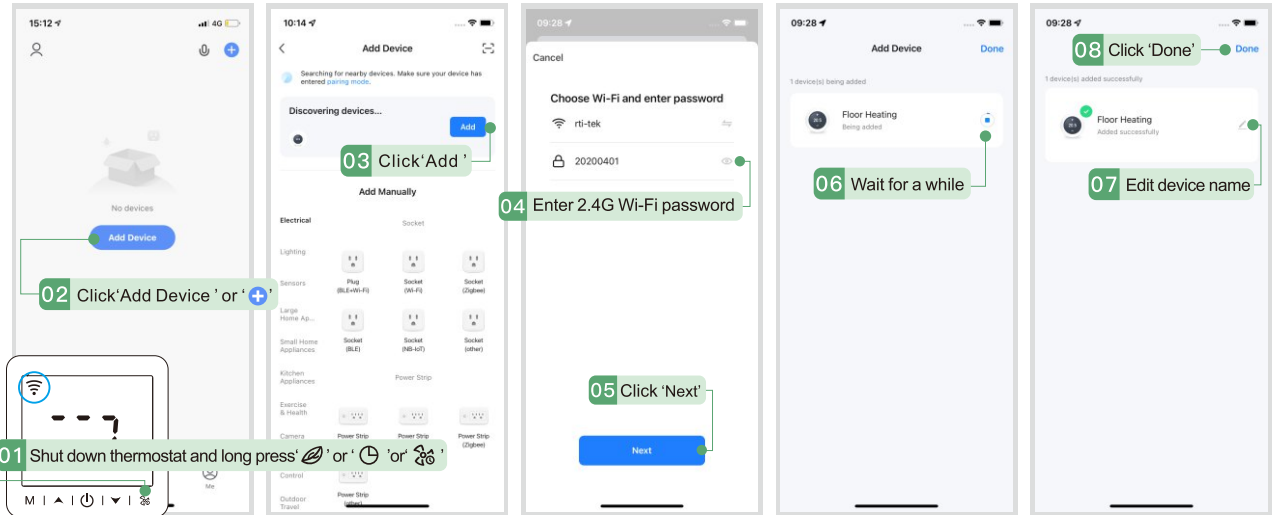

1 Sign Up & Log in

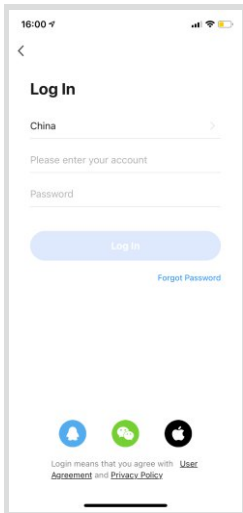

① Scan the QR code above, or search “Smart Life” in Apple APP Store and Google Play, to download Smart Life app.

② Sign up or log in directly if you have an account.

3 AP Mode

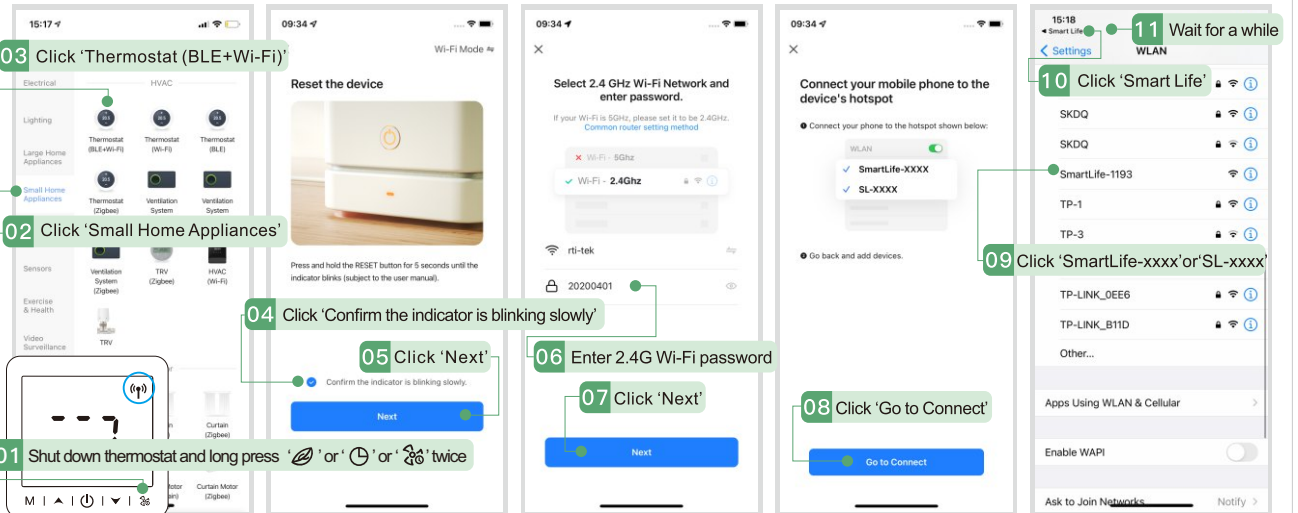

4 Device sharing

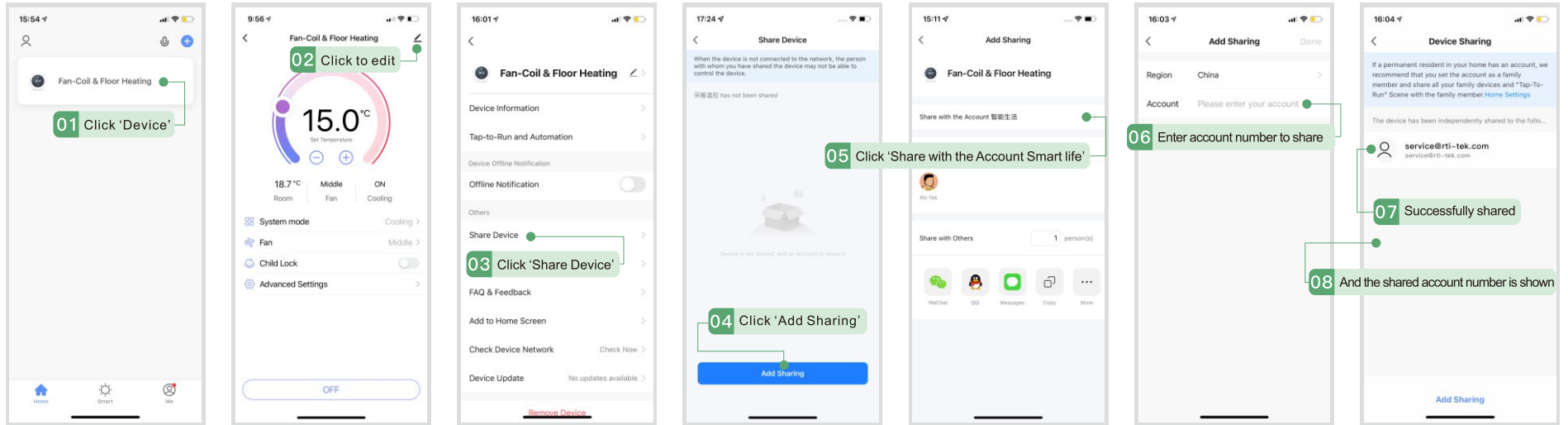

5 App control interface

